

MACKIE®

CFX SERIES OWNER'S MANUAL AND WARRANTY REGISTRATION

12, 16, AND 20-CHANNEL MIC/LINE MIXERS WITH DIGITAL EFFECTS

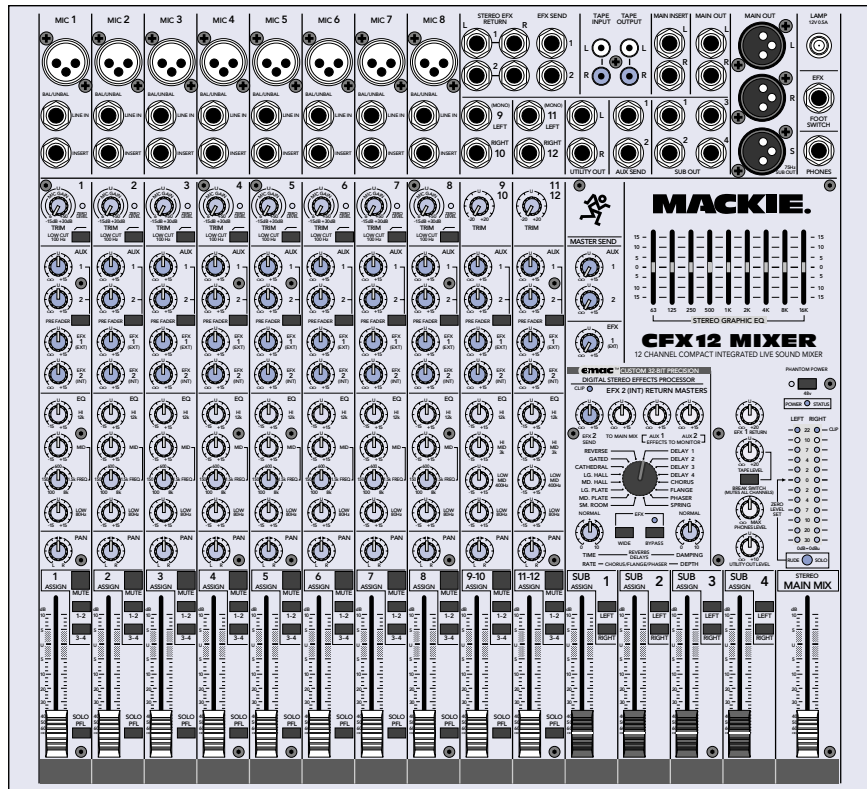
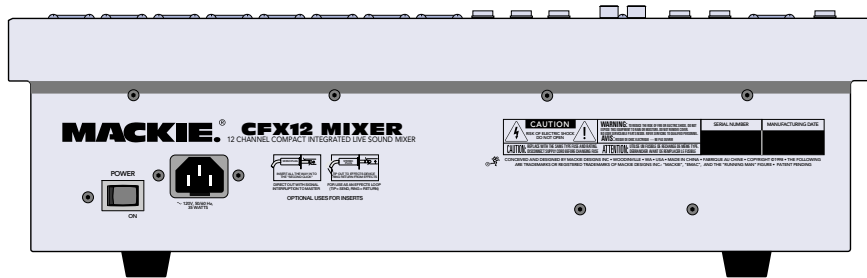

<div style="display: inline-block; text-align: center; background-color: black; color: white; padding: 2px 10px;">CAUTION AVIS</div>
RISK OF ELECTRIC SHOCK DO NOT OPEN RISQUE DE CHOC ELECTRIQUE NE PAS OUVRIR
CAUTION: TO REDUCE THE RISK OF ELECTRIC SHOCK DO NOT REMOVE COVER (OR BACK) NO USER-SERVICEABLE PARTS INSIDE REFER SERVICING TO QUALIFIED PERSONNEL ATTENTION: POUR EVITER LES RISQUES DE CHOC ELECTRIQUE, NE PAS ENLEVER LE COUVERCLE. AUCUN ENTRETIEN DE PIECES INTERIEURES PAR L'USAGER. CONFIER L'ENTRETIEN AU PERSONNEL QUALIFIE. AVIS: POUR EVITER LES RISQUES D'INCENDIE OU D'ELECTROCUTION, N'EXPOSEZ PAS CET ARTICLE A LA PLUIE OU A L'HUMIDITE



The lightning flash with arrowhead symbol within an equilateral triangle is intended to alert the user to the presence of uninsulated "dangerous voltage" within the product's enclosure that may be of sufficient magnitude to constitute a risk of electric shock to persons.

Le symbole éclair avec point de flèche à l'intérieur d'un triangle équilatéral est utilisé pour alerter l'utilisateur de la présence à l'intérieur du coffret de "voltage dangereux" non isolé d'ampleur suffisante pour constituer un risque d'électrocution.



The exclamation point within an equilateral triangle is intended to alert the user of the presence of important operating and maintenance (servicing) instructions in the literature accompanying the appliance.

Le point d'exclamation à l'intérieur d'un triangle équilatéral est employé pour alerter les utilisateurs de la présence d'instructions importantes pour le fonctionnement et l'entretien (service) dans le livret d'instruction accompagnant l'appareil.

SAFETY INSTRUCTIONS

- 1. Read Instructions** — All the safety and operation instructions should be read before this Mackie product is operated.
- 2. Retain Instructions** — The safety and operating instructions should be kept for future reference.
- 3. Heed Warnings** — All warnings on this Mackie product and in these operating instructions should be followed.
- 4. Follow Instructions** — All operating and other instructions should be followed.
- 5. Water and Moisture** — This Mackie product should not be used near water — for example, near a bathtub, washbowl, kitchen sink, laundry tub, in a wet basement, near a swimming pool, swamp or salivating St. Bernard dog, etc.
- 6. Cleaning** — Clean only with a dry cloth.
- 7. Ventilation** — This Mackie product should be situated so that its location or position does not interfere with its proper ventilation. For example, the Component should not be situated on a bed, sofa, rug, or similar surface that may block any ventilation openings, or placed in a built-in installation such as a bookcase or cabinet that may impede the flow of air through ventilation openings.
- 8. Heat** — This Mackie product should be situated away from heat sources such as radiators, or other devices which produce heat.
- 9. Power Sources** — This Mackie product should be connected to a power supply only of the type described in these operation instructions or as marked on this Mackie product.
- 10. Power Cord Protection** — Power supply cords should be routed so that they are not likely to be walked upon or pinched by items placed upon or against them, paying particular attention to cords at plugs, convenience receptacles, and the point where they exit this Mackie product.
- 11. Object and Liquid Entry** — Care should be taken so that objects do not fall on, and liquids are not spilled into, this Mackie product.

12. Damage Requiring Service — This Mackie product should be serviced only by qualified service personnel when:

- A.** The power-supply cord or the plug has been damaged; or
- B.** Objects have fallen, or liquid has spilled into this Mackie product; or
- C.** This Mackie product has been exposed to rain; or
- D.** This Mackie product does not appear to operate normally or exhibits a marked change in performance; or
- E.** This Mackie product has been dropped, or its chassis damaged.

13. Servicing — The user should not attempt to service this Mackie product beyond those means described in this operating manual. All other servicing should be referred to the Mackie Service Department.

14. To prevent electric shock, do not use this polarized plug with an extension cord, receptacle or other outlet unless the blades can be fully inserted to prevent blade exposure.

Pour prévenir les chocs électriques ne pas utiliser cette fiche polarisée avec un prolongateur, un prise de courant ou une autre sortie de courant, sauf si les lames peuvent être insérées à fond sans laisser aucune partie à découvert.

15. Grounding or Polarization — Precautions should be taken so that the grounding or polarization means of this Mackie product is not defeated.

16. Power Precaution — Unplug this Mackie product during lightning storms or when unused for long periods of time. Note that this Mackie product is not completely disconnected from the AC mains service when the power switch is in the OFF position.

17. This apparatus does not exceed the Class A/Class B (whichever is applicable) limits for radio noise emissions from digital apparatus as set out in the radio interference regulations of the Canadian Department of Communications.

ATTENTION — Le présent appareil numérique n'émet pas de bruits radioélectriques dépassant les limites applicables aux appareils numériques de class A/de class B (selon le cas) prescrites dans le règlement sur le brouillage radioélectrique édicté par les ministères des communications du Canada.

18. Exposure to extremely high noise levels may cause permanent hearing loss. Individuals vary considerably in susceptibility to noise-induced hearing loss, but nearly everyone will lose some hearing if exposed to sufficiently intense noise for a period of time. The U.S. Government's Occupational Safety and Health Administration (OSHA) has specified the permissible noise level exposures shown in the following chart.

According to OSHA, any exposure in excess of these permissible limits could result in some hearing loss. To ensure against potentially dangerous exposure to high sound pressure levels, it is recommended that all persons exposed to equipment capable of producing high sound pressure levels use hearing protectors while the equipment is in operation. Ear plugs or protectors in the ear canals or over the ears must be worn when operating the equipment in order to prevent a permanent hearing loss if exposure is in excess of the limits set forth here.

Duration Per Day In Hours	Sound Level dBA, Slow Response	Typical Example
8	90	Duo in small club
6	92	
4	95	Subway Train
3	97	
2	100	Very loud classical music
1.5	102	
1	105	Patrice screaming at Ron about deadlines
0.5	110	
0.25 or less	115	Loudest parts at a rock concert

WARNING — To reduce the risk of fire or electric shock, do not expose this appliance to rain or moisture.

INTRODUCTION

Thank you for choosing a Mackie Designs CFX™ Mixer! These compact live-sound mixers are designed to meet the sound reinforcement needs of almost any small to medium-sized club, meeting room, sanctuary, or outdoor gathering.

Here's a quick glance at all the features you've acquired:

8, 12, or 16 mono channels, with:

- Variable input trim (+6 to +50 dB mic, -15 to +30 dB line)
- Phantom power (globally switched)
- Zero Level gain setting indicator LED
- Switchable 100Hz low-cut filter
- TRS insert jack
- 2 pre/post-fader aux sends
- 2 post-fader effects sends
- 3-band mid-sweep EQ
- Pan, mute, and 1-2/3-4 busing
- PFL solo
- 60mm mono fader

2 stereo line channels, with:

- Variable input trim (-20 to +20 dB)
- 2 pre/post-fader aux sends
- 2 post-fader effects sends
- 4-band EQ
- Pan, mute, and 1-2/3-4 busing
- PFL solo
- 60mm stereo fader

Comprehensive master section, with:

- Four 60mm submix mono faders
- Separate Left & Right assign for each sub
- 60mm main mix stereo fader
- TRS insert jacks for main mix
- Balanced XLR stereo main outputs
- Balanced XLR mono subwoofer output
- 12-segment stereo LED metering
- Mackie's (in)famous Rude Solo Light
- 9-band stereo graphic EQ (main mix)
- EMAC™ 32-bit digital stereo effects with footswitch jack
- 2 aux sends with master level controls
- 2 effects sends with master level controls
- Level controls for stereo effect returns
- Break switch for 'worry-free' intermissions
- RCA tape out
- RCA tape in with stereo level control
- Headphone output with level control
- Utility out with level control
- 12V BNC lamp socket

ABOUT THIS MANUAL

Absolutely most important page:

Before you start engineering, please read the "Quick Start" section on page 5. It's a list of steps that will familiarize you with the CFX Mixer and help you set up a basic performance.

About those blue numbers:

You'll notice numbers in blue circles, like this: **17**. Every feature on the CFX Mixer has one of these numbers assigned to it. Whenever a feature is mentioned, described or illustrated, its number will be right next to it.

Please write your serial number here for future reference (i.e., insurance claims, tech support, return authorization, etc.):

Purchased at:

Date of purchase:



CONTENTS

SAFETY INSTRUCTIONS	2	MASTER SECTION FEATURES	15
INTRODUCTION	3	35 MAIN MIX FADER	15
ABOUT THIS MANUAL	3	36 METERS	15
QUICK START	5	37 RUDE SOLO	15
APPLICATIONS DIAGRAMS	6	38 STEREO GRAPHIC EQ	15
PATCHBAY FEATURES	8	39 TAPE LEVEL	16
1 MIC	8	40 BREAK SWITCH	16
2 LINE IN	8	41 PHONES LEVEL	16
3 INSERT	8	42 UTILITY OUT LEVEL	16
EFFECTS: SERIAL OR PARALLEL?	9	43 SUB FADERS	16
4 STEREO LINE IN	9	44 LEFT/RIGHT SUB ASSIGN	16
5 MAIN OUT	9	45 AUX MASTER SEND	17
6 SUBWOOFER OUT	9	46 EFX 1 MASTER SEND	17
7 MAIN INSERT	9	47 EFX 1 RETURN	17
8 UTILITY OUT	10	48 EMAC EFFECTS PROCESSOR	17
9 SUB OUT	10	48 EFX 2 SEND	17
10 AUX SEND	10	50 TO MAIN MIX	17
11 EFX SEND	10	51 EFFECTS TO MONITOR	18
12 STEREO EFX RETURN	10	52 PRESET SELECT	18
13 TAPE INPUT	11	53 TIME/RATE	19
14 TAPE OUTPUT	11	54 DAMPING/DEPTH	19
15 PHONES	11	55 WIDE	19
16 EFX FOOTSWITCH	11	56 BYPASS	19
17 LAMP	11	57 CLIP	19
18 AC POWER INPUT	11	GENERAL PRECAUTIONS AND CONSIDERATIONS	20
19 POWER SWITCH	11	APPENDIX A: Service Info	20
20 POWER STATUS	11	Warranty Service	20
CHANNEL STRIP FEATURES	12	Troubleshooting	20
21 PHANTOM POWER	12	Repair	21
22 TRIM	12	APPENDIX B: Technical Info	21
23 ZERO LEVEL	12	Specifications	21
24 LOW CUT	12	Block Diagram	22
25 AUX	12	Contributors and Colophon	23
26 PRE FADER	13	CFX SERIES LIMITED WARRANTY	23
27 EFX 1 (EXT)	13		
28 EFX 2 (INT)	13		
29 EQ	13		
30 PAN	14		
31 MUTE	14		
32 ASSIGN	14		
33 FADER	14		
34 SOLO PFL	14		



Don't forget to visit our website at www.mackie.com
for more information about this and other Mackie products.

QUICK START



We know you can't wait to get the show on the road. Who has time to read a booooring manual? That's fine — the CFX Mixer is designed to set up quickly and operate intuitively — but please, **READ THIS PAGE!**

ZERO THE CONSOLE:

1. Turn everything off, including the mixer's POWER switch and PHANTOM POWER switch.
2. Channel strip TRIM, AUX, EFX, and Fader down.
3. STEREO GRAPHIC EQ sliders centered.
4. MASTER AUX and EFX SENDS, and EFX RETURNS down.
5. Channel strip EQ and PAN controls centered.
6. Channel strip ASSIGN 1-2 and MUTE switches *down*.
7. Channel strip LOW CUT, PRE FADER, and ASSIGN 3-4 switches *up*.
8. SUB 1 ASSIGN LEFT, SUB 2 ASSIGN RIGHT *down*; all other SUB ASSIGN switches *up*.
9. MAIN MIX and SUB Faders down.

MAKE THE CONNECTIONS:

1. Connect your amp's outputs to your speaker inputs (unless, of course, you have powered monitors).
2. Plug all the sound system components into suitable AC outlets, properly grounded and capable of delivering adequate current.
3. Using XLR or TRS cables, make connections from your mixer's MAIN OUT to your amplification system's line inputs.
4. Make connections from your microphones and instruments to the mixer: Connect balanced microphones to the mono channel MIC jacks. (For condenser microphones, engage the PHANTOM POWER switch, located just above the meters.) Connect line-level instruments (synthesizers, guitar effects, direct boxes) to the mono or stereo channel LINE IN TRS jacks.
5. Turn all the power switches on, *leaving the amplifier's switch for last*.
6. Turn up the MAIN MIX Fader to the "-30" label, for now. We'll crank it up later on.
7. Turn up SUB Faders 1 and 2 to unity gain ("U" label).

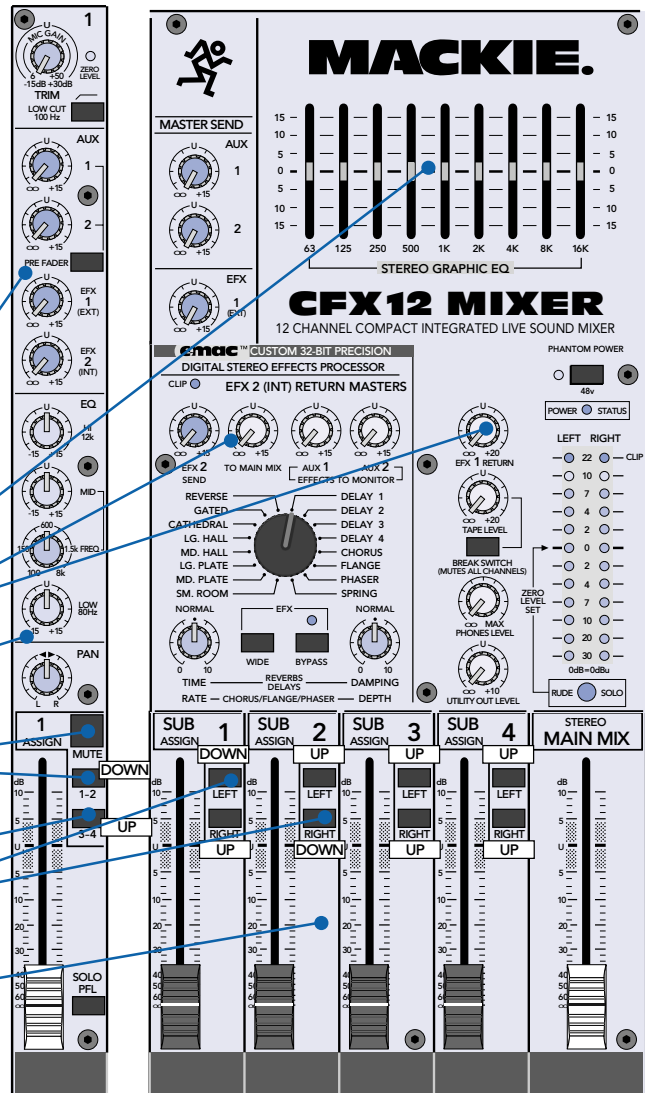

SET THE LEVELS:

1. Choose one of the microphones or instruments you connected. Make some noise. If it's a microphone, sing at your normal singing volume. If it's a synthesizer, play it at its normal output level.
2. While making noise, turn up that channel's TRIM until the adjacent ZERO LEVEL starts blinking.
3. Disengage (up) that channel's MUTE.
4. Raise that channel's fader to unity gain ("U" label). You should be hearing your noise now.
5. If necessary, apply channel EQ changes. (You may need to compensate for level changes with the channel fader.)
6. Repeat steps 1 through 5 for the remaining active channels.
7. Stop making noise. Everyone: start making music.

TWEAK THE MIX:

1. Engage MUTE on all channels except your rhythm section (drums & bass).
2. Adjust the rhythm section's channel faders to get a good balance of levels.
3. Un-mute the other active channels and adjust their faders.
4. Now that you have a rough mix going, turn up the MAIN MIX Fader to a comfortable listening level.
5. If the overall mix has an equalization problem, make adjustments to the STEREO GRAPHIC EQ. If an individual channel is the problem, use its EQ instead.
6. Using channel EFX 2 (INT) and the EMAC EFFECTS PROCESSOR, experiment with adding some effects.
7. Depending on how much time you've got, keep tweaking. Walk the room to see how it sounds away from your mixer. Keep tweaking.

KNOW THESE THINGS:

- Never listen to loud music for prolonged periods. Please see "Safety Instructions" on page 2 for information on hearing protection.
- Never plug amplifier outputs into anything except speakers.
- Never use guitar cables to connect amplifiers to speakers.
- Before making connections to an external amp or reconfiguring an amp's routing, turn the amp's level (gain) controls down, turn the power off, make the changes, turn the power back on, and then turn the level controls back up.
- When you shut down your equipment, turn off any external amplifiers first. When powering up, turn on the amplifiers last.
- Save the shipping box and packing material! You may need them someday, and you probably don't want to have to pay for that again.

APPLICATIONS DIAGRAMS

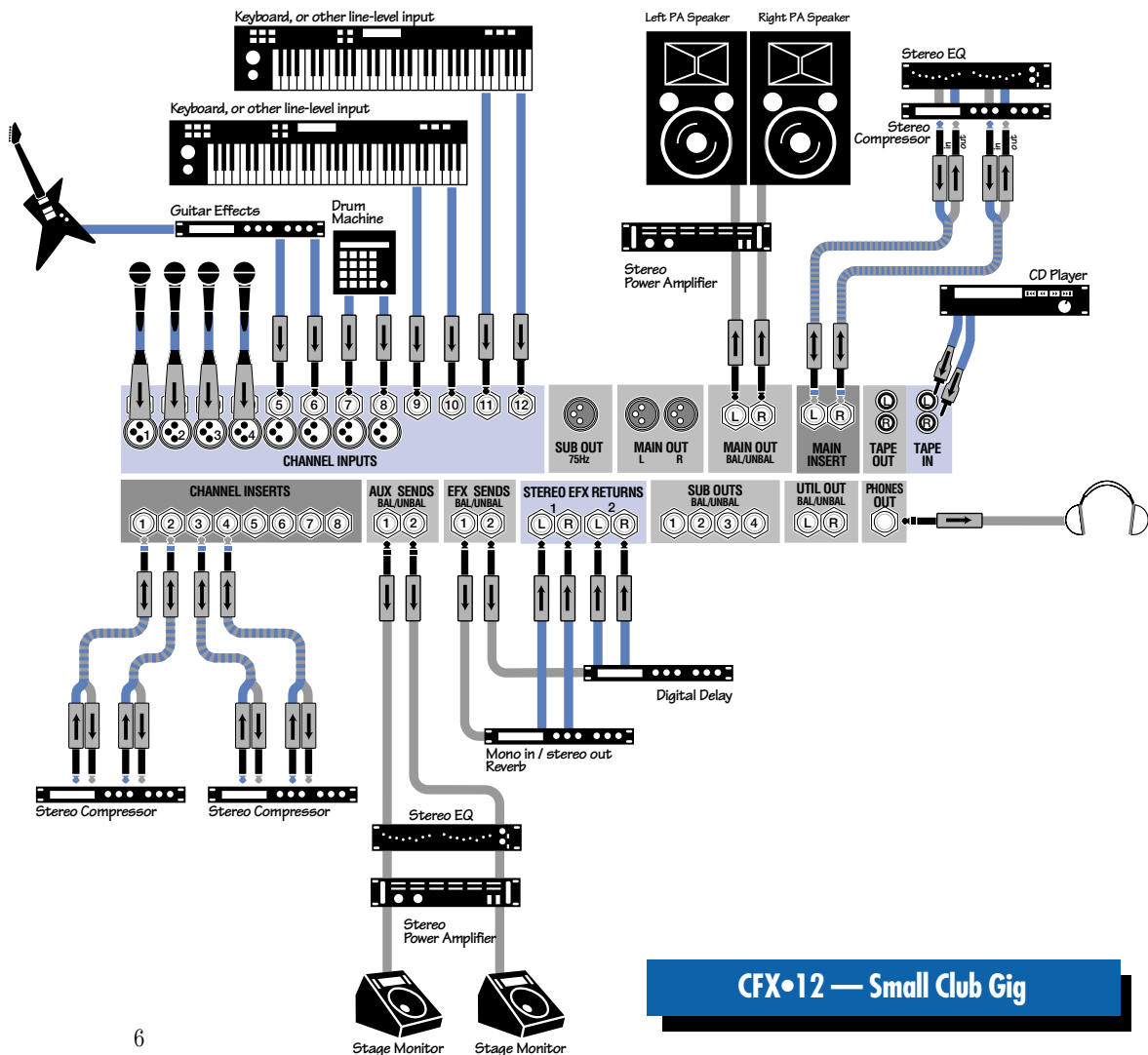

CFX-12 — Small Club Gig

CFX•16 — Large Club Gig or Auditorium using a Subwoofer

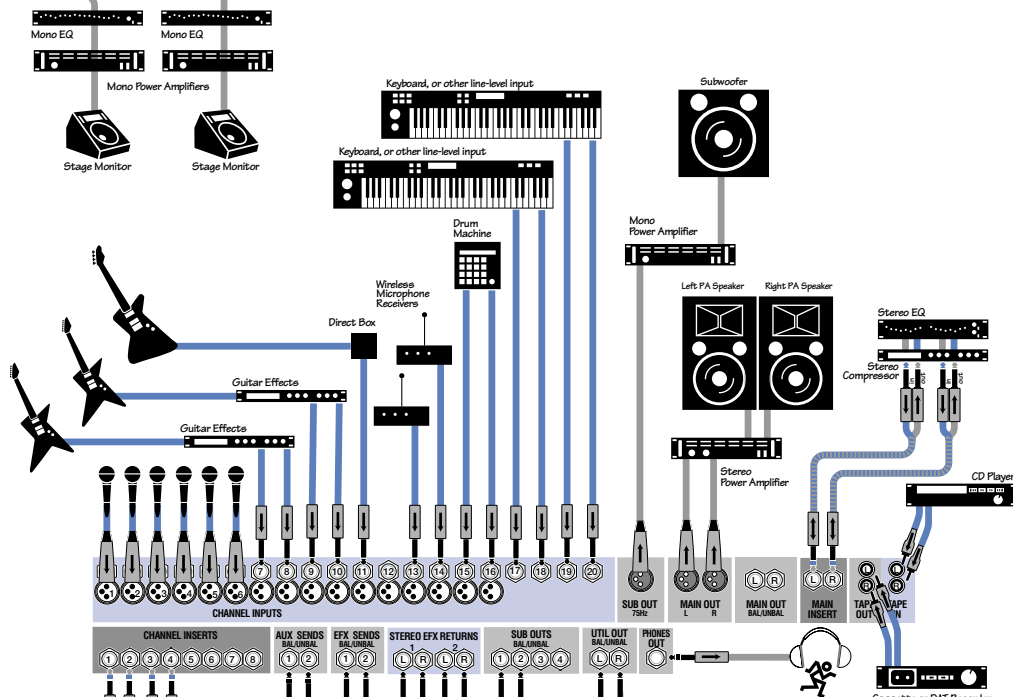
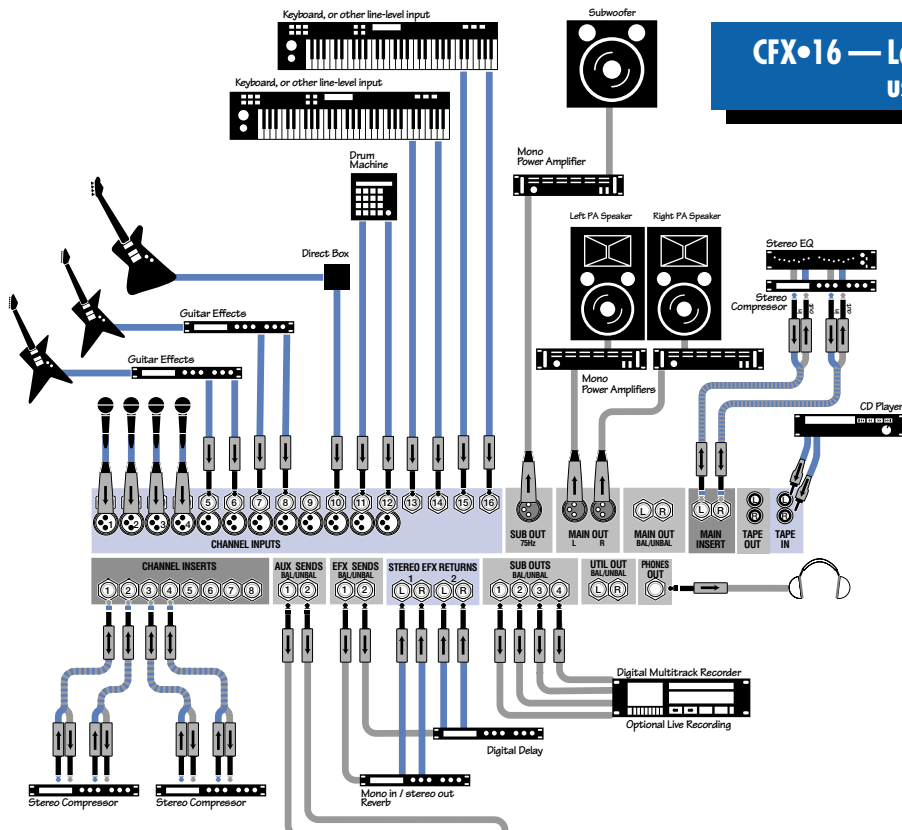

CFX•20 — Church Sound Reinforcement with Separate Utility Mix

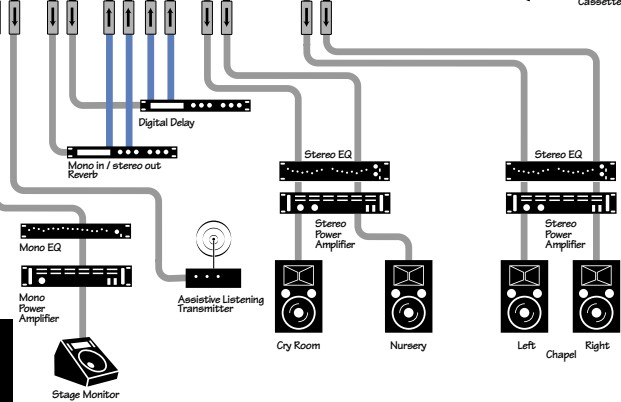

PATCHBAY FEATURES

At the risk of stating the obvious, this is where you plug everything in: microphones, line-level instruments, effects, headphones and the ultimate destination for your sound: PA system, tape recorder, etc.

1 MIC

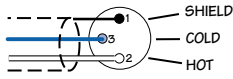

XLR BALANCED WIRING

The CFX Mixer is equipped with rugged, low noise, phantom-powered microphone preamplifiers, providing up to 50 dB of crystal-clear amplification. Their balanced circuitry rejects all manner of extraneous interference. Professional condenser, dynamic, and ribbon mics will all sound excellent through these XLR inputs.

You can plug in almost any kind of balanced mic that has a standard XLR-type male mic connector.

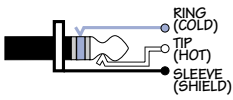

TRS BALANCED WIRING

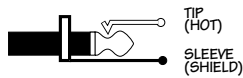

TS UNBALANCED WIRING

2 LINE IN

The line inputs share circuitry (but not phantom power) with the mic preamps, and can be driven by balanced or unbalanced sources at almost any level. You can use these TRS inputs for virtually any signal you'll come across, from -25 dBu up to +38 dBu.

3 INSERT

This is where you connect serial effects such as compressors, equalizers, de-essers or filters. The send is low-impedance (150 ohms), capable of driving any line-level device. The return is high-impedance (10k ohms) and can be driven by almost any device.

These unbalanced jacks are configured thusly:

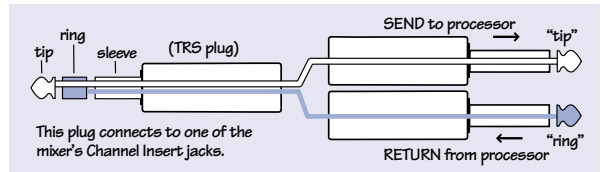

Tip = Send (to effects device input)
Ring = Return (from effects device output)
Sleeve = Common ground (connect shield to all three sleeves)

Specialty "Y" cables, developed just for these jacks, are widely available.

Besides being used for inserting external devices, these jacks can also be used as channel direct outputs; post-TRIM, post-LOW CUT, and pre-EQ. Here are three ways you can use the channel INSERT jacks:

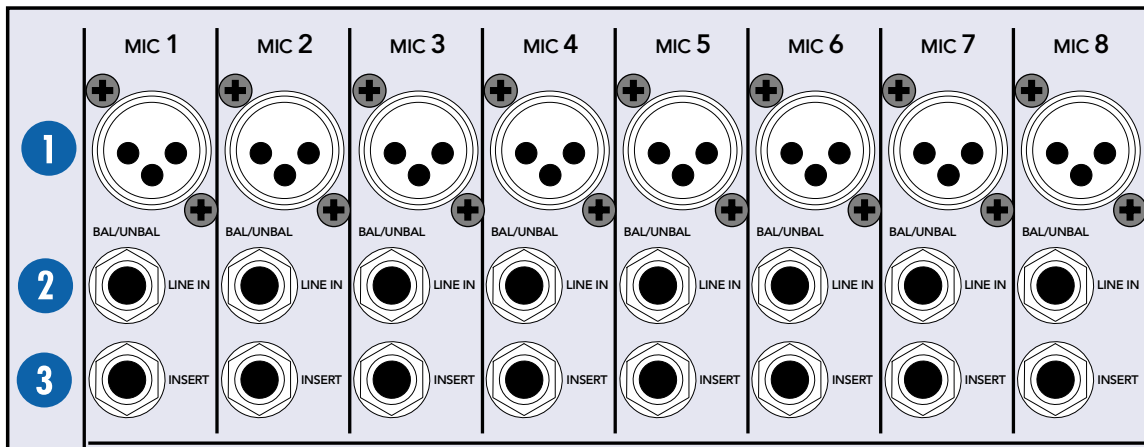
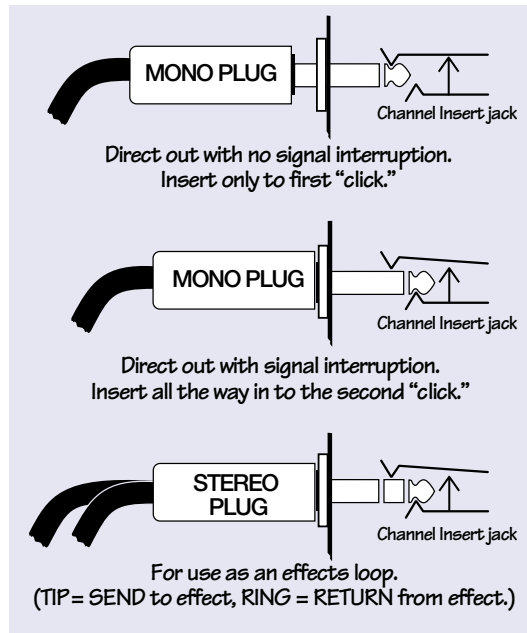

EFFECTS: SERIAL OR PARALLEL?



Effects devices are used either in serial or in parallel: “Serial” means that the entire signal is routed through the effects device.

Examples: preamps, compressor/limiters, graphic equalizers.

“Parallel” means that a portion of the signal is tapped off to the device (usually via a mixer’s aux send), processed and returned (usually via a mixer’s aux return), to be mixed with the original “dry” signals. Multiple signals (via multiple mixer channels) can all make use of the same parallel effects device. Examples: reverb, digital delay, chorus. See diagrams below.

Serial Device

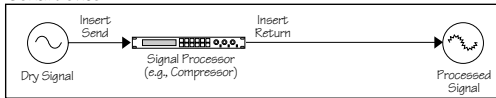

Parallel Device

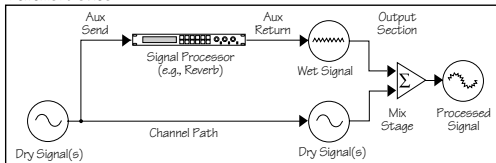

4 STEREO LINE IN

These balanced inputs are designed for stereo or mono, balanced or unbalanced signals, from -20 dB to $+20$ dB. These TRS inputs can be used with just about any professional or semipro instrument, effect or tape player.

When connecting a mono device (just one cord), always use the **LEFT (MONO)** input and plug nothing into the **RIGHT** input. A trick called “jack normaling” will cause the signal to appear on both sides.

5 MAIN OUT

Coming in two flavors, XLR and TRS, the main output represents the end of the mixer chain, where your fully mixed and enhanced stereo signal enters the real world.

The XLR balanced outputs will add 6 dB when connected to balanced inputs, thereby elevating signal from the noise floor by that amount.

The TRS balanced outputs offer the advantage of having no 6 dB level change to deal with, while still providing extraneous noise rejection.

6 SUBWOOFER OUT

The CFX Mixer has an integrated mono-summing 75Hz 3rd-order low-pass filter. It taps the left and right **MAIN OUT 5** signals, mixes them into a mono signal, then removes all but the deepest bass information. Patch this balanced XLR output to a high-powered mono-summed amp and subwoofer (or an active subwoofer), and the music police will be right over.

7 MAIN INSERT

With nothing plugged into these jacks, the mix signal goes from the mix amp straight through to the **MAIN MIX Faders 35**. But when you plug a serial device into these jacks, the mix leaves the mixer, goes through the device and back into the mixer’s main mix faders.

If you want to send your main mix through a compressor/limiter or similar device, these are the jacks for you. Since the insert is before the mix faders, moving the fader will not alter the signal strength sent to the compressor, thereby preserving its compression characteristics.

These unbalanced jacks are configured the same as the channel strip insert jacks. See page 8 for wiring and usage information.

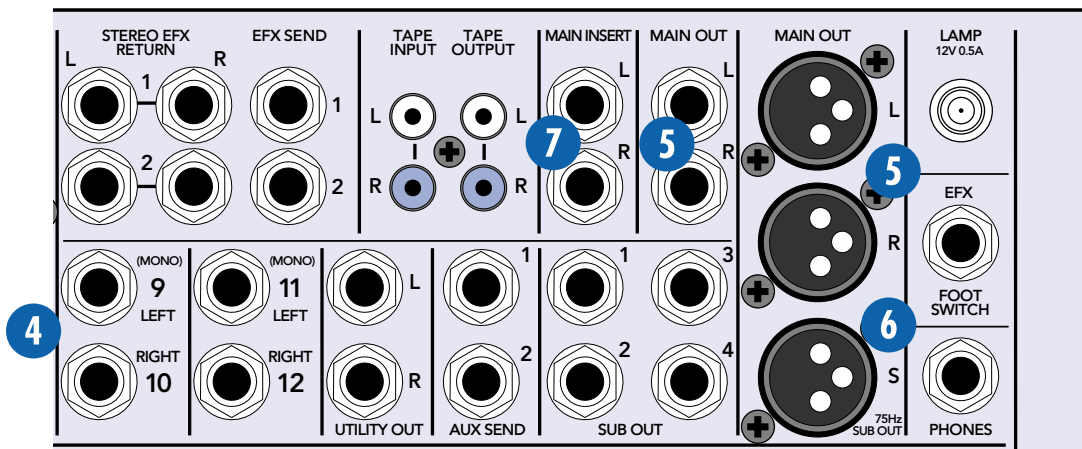

8 UTILITY OUT

The stereo signal at these TRS jacks is the same as at the MAIN OUT 5, but with one important difference:

After the MAIN MIX Fader 35, the mix is sent through the UTILITY OUT LEVEL 42 control, allowing you to set levels as desired without disturbing the main mix level.

9 SUB OUT

In live sound applications, these TRS jacks can be patched into one or two stereo amplifiers, thereby allowing you to control levels independently via the SUB Faders 43.

Alternatively, use the MAIN OUT 5 to feed the amplifiers and one stereo SUB OUT 9 pair to feed a recorder.

In studio applications, these outputs can be used as four separate paths to feed four tracks of a multitrack recorder.

See ASSIGN 32 and SUB ASSIGN 44 for more information.

10 AUX SEND

To create a stage monitor mix, with levels set independently from the main mix, patch these TRS jacks into your monitor amplifier inputs. These jacks can also be used to feed the inputs of an effects device.

See AUX 25 and PRE FADER 26 for more information.

11 EFX SEND

The signal at these TRS outputs is post-fader only, so they cannot be used as traditional stage monitor cues. They're intended to patch into effects device inputs; hence the name "EFX." See EFX 1 (EXT) 27 and EFX 2 (INT) 28 for more information.

Note: The EFX 2 signal path also feeds the CFX Mixer's internal EMAC EFFECTS PROCESSOR 48 inputs. If you're using EMAC and just one outboard processor, patch that processor via EFX SEND 1 for independent control of the effects send level.

We recommend going into a stereo reverb in mono and returning in stereo. We have found that on most "stereo" reverbs the second input just ties up an extra EFX send and adds nothing to the sound. There are exceptions, so feel free to try it both ways. If your effects device is true stereo all the way through, use EFX SEND 1 to feed its left input and EFX SEND 2 to feed the right input.

12 STEREO EFX RETURN

Patch the outputs of external parallel effects devices to these inputs.

Note: The EFX 2 return signal is combined with the signal from the CFX Mixer's internal EMAC EFFECTS PROCESSOR 48. If you're using EMAC and just one outboard processor, patch the outboard processor via EFX 1 RETURN for independent control of the effects return level.

When connecting a mono device (just one cord), always use the LEFT (MONO) input and plug nothing into the RIGHT input. A trick called "jack normalizing" will cause the signal to appear on both sides.

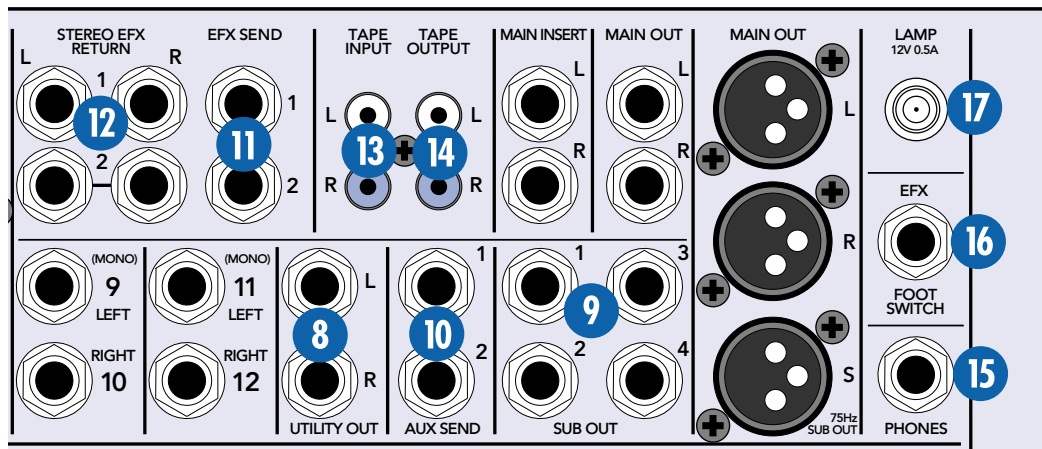
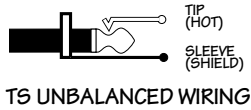
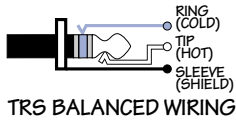

13 TAPE INPUT

Patch the outputs of your intermission entertainment here. Any line-level mono or stereo device can be used: tape, CD player, television audio, etc. See **BREAK SWITCH 40** for more information.

When connecting a mono device (just one cord), you'll need a "Y-splitter" RCA adapter. It turns a mono output cord into two cords; so both the left and right tape input jacks can be patched. This adapter is widely available.

14 TAPE OUTPUT

Use these jacks to capture the entire performance to tape. The signal at these jacks is the main mix, after the **MAIN INSERT 7** but before the **MAIN MIX Fader 35**. The main mix signal will be present at these jacks regardless of the position of the **MAIN MIX Fader**.

15 PHONES

The stereo signal at these jacks is the same as at the **MAIN OUT 5**, but with two important differences:

After the **MAIN MIX Fader 35**, the mix is sent through the **PHONES LEVEL 41** control, allowing you to set levels as desired, without disturbing the main mix level.

When a channel's **SOLO PFL 34** is engaged, the main mix signal at this output will be replaced by the solo signal, allowing the engineer to audition channels without disturbing the main mix.

The stereo **PHONES** jack will drive any standard headphones to very loud levels. Walkperson-type phones can also be used with an appropriate adapter.

Note: Please see the "Safety Instructions" on page 2 for information on hearing protection.

16 EFX FOOT SWITCH

You can connect a normally-open foot switch to this connector to duplicate the function of the **BYPASS 56** switch, located in the **EMAC EFFECTS PROCESSOR 48**. Closing the switch connection causes the **EFX BYPASS** indicator to light and mutes the effects.

Note: When a foot switch is plugged into the **FOOT SWITCH** jack, the **BYPASS** switch is disabled.

Just like the **BYPASS 56** switch, this affects only the internal **EMAC EFFECTS PROCESSOR** and not any device plugged into **STEREO EFX RETURN 2 12**.

17 LAMP

This BNC-type connector will accept almost any of the widely available 12VDC 0.5 amp gooseneck lamps, made by Littlite® and others. If your work involves mixing in the back of dark theaters, this lamp will likely become your best friend.

18 AC POWER INPUT

This IEC Socket is where you connect the supplied AC linecord to provide AC power to the **CFX Mixer**. Plug the cord into a suitable AC outlet, properly grounded and capable of delivering adequate current.

If you happen to lose the AC linecord, replacements are available at any office/computer supply store.

19 POWER SWITCH 20 POWER STATUS

The **POWER 19** switch is located on the rear panel, adjacent to the **AC Power Input 18**. Push the side of the switch labeled "ON" to turn the mixer on; you should see the **POWER STATUS 20** LED glow in confirmation. To turn the mixer off, push the switch the other way. (Let's all say a big collective "Duh.")

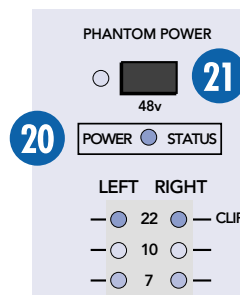
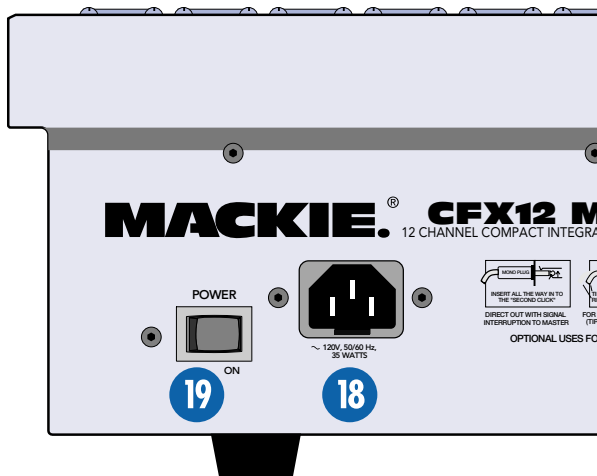
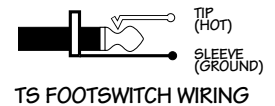
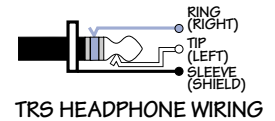
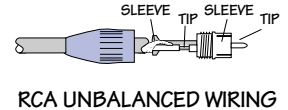

CHANNEL STRIP FEATURES

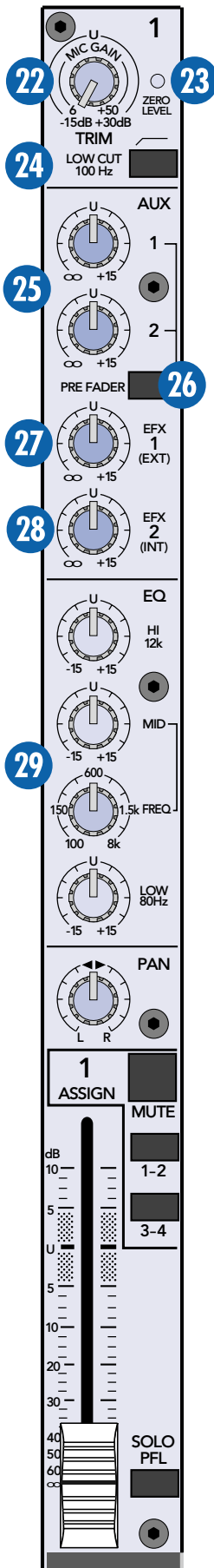

Mono Channel

21 PHANTOM POWER

Ha! We tricked you! The phantom power switch is not located in the channel strip section at all! It's way over on the right side of the mixer (see graphic on previous page). We're just mentioning it here since it applies to the channels; specifically, what type of microphones you have plugged into them.

Push in this switch to provide phantom power to the XLR MIC 1 input jacks. All of the XLR mic inputs are capable of providing phantom power. Phantom power is required to operate most condenser microphones (some condenser microphones are battery-powered). The CFX Series provide +48VDC phantom powering on pins 2 and 3 of the XLR connectors.

If you have dynamic, ribbon, or tube mics that do not require phantom power, leave the PHANTOM POWER switch out. If you are using both condenser and dynamic mics, don't worry. Phantom power will not hurt most dynamic mics. Check the microphone's user manual if you're not sure.



Caution: Turn all output levels down before operating this switch to avoid the possibility of a "pop" in your speakers.

Connecting an external line-level device to an XLR input connector with the phantom power switched on could damage the device. We recommend using the LINE IN 2 and STEREO LINE IN 4 jacks for connecting line-level signals.

22 TRIM

If you haven't already, please read the "SET THE LEVELS" portion of "QUICK START," on page 5.

TRIM adjusts the input sensitivity of the mic and line inputs connected to the channels, mono and stereo. This allows signals from the outside world to be adjusted to optimal internal operating levels.

If the signal originates through a mono channel's MIC 1 XLR jack, there will be 6 dB of gain with the knob fully down, ramping to 50 dB of gain fully up.

Through a mono channel's LINE IN 2 TRS input, there is 15 dB of attenuation fully down and 30 dB of gain fully up, with a "U" (unity gain) mark at 12:00 (knob halfway up).

Through a stereo channel's stereo LINE IN 4 TRS inputs, there is 20 dB of attenuation fully down and 20 dB of gain fully up, with a "U" (unity gain) mark at 12:00 (knob halfway up).

Having 20 dB of line-level attenuation can be very handy when you are injecting a signal that is very hot, when you want to add a lot of EQ boost, or both. Without this "virtual pad," it would be very difficult to control the signal and might lead to channel clipping.

23 ZERO LEVEL

This handy LED, which (we hope) you already read about in "QUICK START," is triggered to glow when it receives an audio signal at or above 0 dBu.

If the LED is glowing, as opposed to flickering, turn the TRIM 22 down. If the LED is doing almost nothing, turn the TRIM up.

For a more accurate method of setting trim levels, please see RUDE SOLO 37 (page 15), where a soloed signal will appear on the mixer's meters 36.

24 LOW CUT

The LOW CUT switch, often referred to as a High Pass Filter (depends on how you look at it), cuts bass frequencies below 100Hz at a rate of 18 dB per octave.

We recommend that you use LOW CUT on every microphone application except kick drum, bass guitar, or bass-heavy synth patches. LOW CUT can also help reduce the possibility of feedback in live situations and it helps to conserve amplifier power.

25 AUX

These knobs tap a portion of each channel signal and send it out, via the AUX SEND 10 jacks, to an external device for parallel effects processing or stage monitoring.

AUX levels are controlled by these AUX knobs and by the AUX MASTER SENDS 45. These are more than mere effects and monitor sends: they can be used to generate separate mixes for recording or "mix-minuses" for broadcast.

Each AUX knob's level ranges from off through unity (the center detent position) on up to 15 dB of extra gain (fully clockwise).

The line-level stereo channels' AUX knobs control a mono sum of the channel's stereo signals. For instance, on the CFX•20, channel 17 (L) and 18 (R) mix together to feed that channel's AUX send knobs.

26 PRE FADER

The aux send rule of thumb: For parallel effects processing, use aux sends in post-fader mode. For stage monitors, use pre-fader mode (see diagram below).

With this switch disengaged (up), AUX 1 and 2 receive signals in post-fader mode: post-low cut, post-insert, post-EQ, post-mute, and POST-fader. Any changes made to the channel controls will affect the AUX signal.

With this switch engaged (down), AUX 1 and 2 receive signals in pre-fader mode: post-low cut, post-insert, post-EQ, post-mute, and PRE-fader. Any changes made to the channel controls, EXCEPT the fader, will affect the AUX signal.

In pre-fader mode, you can take the drummer's vocals out of the main mix by turning his fader down, but since he still hears himself in the monitors, he's happy.

27 EFX 1 (EXT)

EFX 1, designed for feeding the inputs of parallel effects devices, behaves exactly like an AUX 25 send, but it's always in post-fader mode: Any changes made to the channel controls will affect the EFX signal. The PRE FADER 26 switch has no effect on the EFX sends.

28 EFX 2 (INT)

EFX 2 is identical to EFX 1 with one big difference: In addition to feeding the EFX SEND 11 jacks, it also feeds the inputs to the EMAC EFFECTS PROCESSOR 48. If you're using EMAC and just one outboard processor, patch the outboard processor via EFX RETURN 1. You can use EMAC and an outboard device via EFX 2; just remember that the sends (EFX 2 (INT) 28, EFX 2 SEND 49) and returns (TO MAIN MIX 50) control two devices. The PRE FADER 26 switch has no effect on the EFX sends; they're always post-fader.

29 EQ

The CFX Mixer has low shelving, mid peaking, and high shelving EQ. "Shelving" means that the circuitry boosts or cuts all frequencies past the specified frequency. For example, boosting the LOW EQ knob boosts bass frequencies at

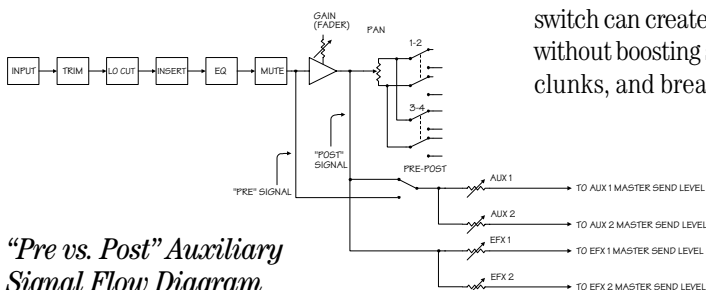

"Pre vs. Post" Auxiliary Signal Flow Diagram

80Hz and below. "Peaking" means that only a selected "hill" of frequencies surrounding a center "hilltop" frequency is affected by the EQ control.

Everything in moderation (including moderation): with EQ, although you can bring a sound to life, you can also screw things up. If you max the EQs on every channel, you'll get mix mush, not to mention driving your mix levels near or beyond clipping. So equalize subtly; use the left sides of the knobs (cut) as well as the right (boost).

HI EQ

This control provides up to 15 dB of boost or cut at 12kHz and above, and it is also flat at the detent. Use it to add sizzle to cymbals or an overall sense of transparency or edge to keyboards, vocals, guitar, and bacon frying. Turn it down a little to reduce sibilance or hide tape hiss.

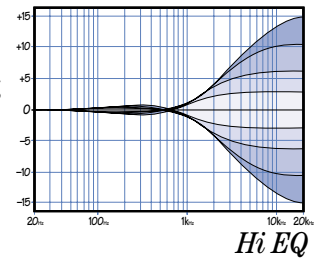

Hi EQ

MID EQ

Short for "midrange," this knob provides 15 dB of boost or cut, also flat at the center detent. Midrange EQ is often considered the most dynamic, because the frequencies that define any particular sound are almost always found in this range. You can create as many interesting and useful EQ changes by turning this knob down as well as up.

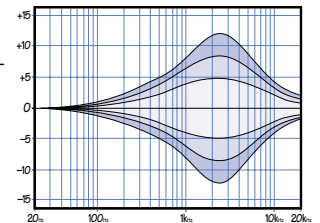

Mid EQ

The mono channels employ a semi-parametric mid-sweep EQ. In addition to being able to set the amount of boost, you can "aim" that boost at a specific frequency; anywhere from 100Hz to 8kHz.

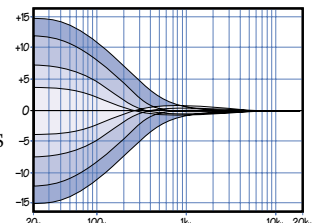

Low EQ

The stereo channels employ a 2-stage fixed-frequency MID EQ. HI-MID is centered at 3kHz; LOW-MID is centered at 400Hz.

LOW EQ

This control provides up to 15 dB of boost or cut at 80Hz and below. The circuit is flat (no boost or cut) at the center detent position. This frequency represents the punch in bass drums, bass guitar, fat synth patches, and high-testosterone male singers.

When adding boost to the channel's low EQ, simultaneously engaging the LOW CUT 24 switch can create an audible low frequency boost without boosting stage rumble, mic handling clunks, and breath pops.

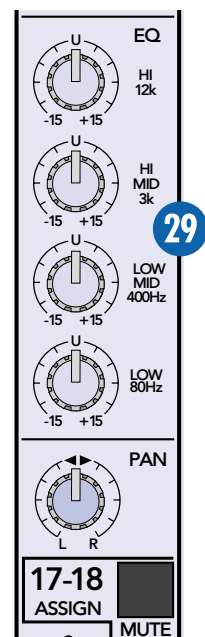

Stereo Channel

30 PAN

PAN adjusts the amount of channel signal sent, left versus right, to the SUB OUTs 9 (and ultimately the MAIN OUTs 5 via the SUB ASSIGN 44 switches). On mono channels, the knob places the signal somewhere between hard left and hard right. On stereo channels, it works like the balance control on your home stereo, by attenuating one side or the other.

With the PAN knob hard left, the signal will feed SUB 1 and SUB 3 (assuming the channel's ASSIGN 32 switches are engaged).

With the PAN knob hard right, the signal will feed SUB 2 and SUB 4 (assuming the channel's ASSIGN 32 switches are engaged).

With the PAN knob set somewhere in between, the signal will be shared across both sides of the mix.

31 MUTE

When you engage a channel's mute switch, its signal disappears from these outputs: MAIN OUT 5, MAIN INSERT 7, SUB OUT 1-4 9, AUX SEND 1 & 2 10, EFX SEND 1 & 2 11 (including the send to the EMAC EFFECTS PROCESSOR 48). The only thing it doesn't mute is the channel's SOLO PFL 34 switch, so you can audition channels, via headphones, without sending them to the main mix.

32 ASSIGN

Used in conjunction with the PAN 30 knob, ASSIGN determines the final destination of a channel's signal. Engaging ASSIGN 1-2, for instance, sends that channel's signal to the SUB 1 and 2 Faders 43 and, via their SUB ASSIGN 44 switches, the MAIN MIX Fader 35.

Typically, ASSIGN 1-2 will be engaged on all channels destined for the main mix. By configuring SUB 1 and 2 to feed the main mix, the channel ASSIGN 1-2 switches become the equivalent of being "Main Mix" switches.

Some channels can use ASSIGN 3-4 instead; creating a submix for a set of channels (all the drum channels, for instance). Then, by configuring SUB 3 and 4 to also feed the main mix, you can "ride" the SUB 3 and 4 Faders 43 independently of the rest of the mix.

SUB Faders 43, SUB ASSIGN 44, and MAIN MIX Fader 35 will explain this further.

33 FADER

Although the most self-explanatory item on a mixer, we'll explain it anyway: The fader is the master level control for the channel's sig-

nal. Subtle adjustment of the channels' fader positions is the key to a finely-tuned mix.

Typically (providing the TRIM 22 knob is set correctly) the fader position will be positioned somewhere between 0 dB ("U") and -30 dB.

If you have a fader set all the way up, adding 10 dB of gain, that's usually a sign that your TRIM 22 knob is set too low. Conversely, if the fader is set way down, your TRIM may be set too high.

"U" LIKE UNITY GAIN



Mackie mixers have a "U" symbol on almost every level control. This "U" stands for "unity gain," meaning no change in signal level. Once you have adjusted the input signal to line-level, you can set every control at "U" and your signals will travel through the mixer at optimal levels. What's more, all the labels on our level controls are measured in decibels (dB), so you'll know what you're doing level-wise if you choose to change a control's settings.

34 SOLO PFL

Engaging a channel's SOLO switch causes this dramatic turn of events: The PHONES 15 and Meters 36, which ordinarily receive the main mix signals, instead receive the SOLO PFL signal. PFL, being a mono signal, is sent to both sides of the PHONES outputs and to the LEFT meter. Additionally, the RUDE SOLO 37 LED flashes obnoxiously to remind you that "you're in solo."

The SOLO PFL signal is tapped before the channel's MUTE 31 and Fader 33 controls. It does, however, follow TRIM 22, LOW CUT 24, and EQ 29 settings, making it the perfect tool for quick inspections of individual or multiple channels. The channel's PAN 30, MUTE 31 and Fader 33 settings have no effect on the SOLO signal. See RUDE SOLO 37 for more information.



WARNING: Pre-fader SOLO taps the channel signal before the fader 33. If you have a channel's fader set well below "U" (unity gain), SOLO won't know that and will send a unity gain signal to the PHONES 15 output. That may result in a startling level boost in your headphones.

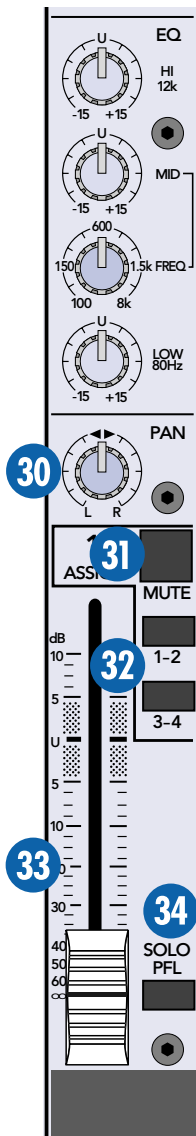

MASTER SECTION FEATURES

We hope you've understood, if not memorized, the CHANNEL STRIP FEATURES you just read. If you're still confused, please look them over again before you tackle this section. Don't worry, it's easy to swallow as long as you take it a bite at a time.

35 MAIN MIX FADER

As the name implies, this stereo fader controls the levels of signals sent to the main outputs: XLR and TRS MAIN OUT 5. The TAPE OUTPUT 14 RCA jacks also receive the main mix, but before the MAIN MIX Fader.

Signals feeding the MAIN MIX Fader, after passing through the STEREO GRAPHIC EQ 38, include: SUB ASSIGN 44, MAIN INSERT 7, STEREO EFX RETURN 1 and 2 12 (including the EMAC EFFECTS PROCESSOR 48), and TAPE INPUT 13. All assigned SUB Faders 43 and EFX RETURNS 47 50 that are not turned fully down will appear in the MAIN MIX.

The fader, set fully up, provides 10 dB of gain. A "U" unity gain point is just below that. When set fully down, the main mix is effectively muted. This is the fader to pull down at the end of the song when you want The Great Fade-Out.

36 METERS

The CFX Mixer's peak metering system is made up of two columns of twelve LEDs each, with thresholds ranging from -30 dB up to "CLIP" (+22 dBu at the TRS MAIN OUT 5, +28 dBu at the XLR MAIN OUT). The meters display the main mix, post MAIN MIX Fader 35, unless a SOLO PFL 34 switch is engaged.

When a SOLO PFL 34 switch is engaged, the meters will instead display the solo information, at unity gain (pre channel fader 33). Why, you ask? The meters, being a tool for the engineer, must display what the engineer is listening to via the PHONES 15 output.

You can get a good mix with the meter's peaks flashing anywhere between -20 and +10 dB. Most amplifiers clip at about +10 dB, and some recorders aren't so forgiving either. For best real-world results, try to keep your peaks between "0" and "+7."



You may already be familiar with "+4" (+4 dBu=1.23V) and "-10" (-10 dBV=0.32V) operating levels. Basically, what determines the operating level is the relative 0 dB VU (or 0VU) chosen for the meters.

A "+4" mixer, with a +4 dBu signal pouring out the back, will actually display 0 dB on its meters. A "-10" mixer, with a -10 dBV signal trickling out, will also display 0 dB. So ... when is 0 dB actually 0 dB? Right now!

At the risk of creating another standard, Mackie's compact mixers address the need of both crowds by calling things as they are: 0 dB (0.775V) at the output shows as 0 dB VU on the meters. What could be easier? (By the way, the most wonderful thing about standards is that there are so many to choose from.)

37 RUDE SOLO

This infamous flashing LED (Light Emitting Diode) serves two purposes — to remind you that at least one SOLO PFL 34 switch is engaged, and to let you know that you're mixing on a Mackie.

Engaging a SOLO PFL 34 switch affects these features: PHONES 15 and Meters 36. No other outputs are affected in any way.

Although the "SET THE LEVELS" section of "QUICK START" (page 5) will get your level-setting tasks accomplished, using the meters 36 in PFL SOLO mode lets you really tune in. Instead of one flickering LED, you can make use of the 12-segment VU display in the meters. How? Just engage a SOLO PFL 34 switch and watch the meters.



WARNING: SOLO is pre-fader and taps the channel signal before the fader 33. If you have a channel's fader set well below "U" (unity gain), SOLO won't know that and will send a unity gain signal to the PHONES 15 output. That may result in a startling level boost in your headphones.

38 STEREO GRAPHIC EQ

This equalizer, used to shape the frequency spectrum of the main mix, is the last thing in the chain prior to the MAIN MIX Fader 35 and MAIN OUT 5 XLR and TRS jacks.

Although there is no actual bypass switch for the STEREO GRAPHIC EQ, by setting all the sliders to zero (center) you'll effectively remove it from the signal path.

How to find and reduce feedback:

1. Set the GRAPHIC EQ sliders to zero (center).
2. Set the TRIM 22 levels, using the ZERO LEVEL 23 or SOLO PFL 34.

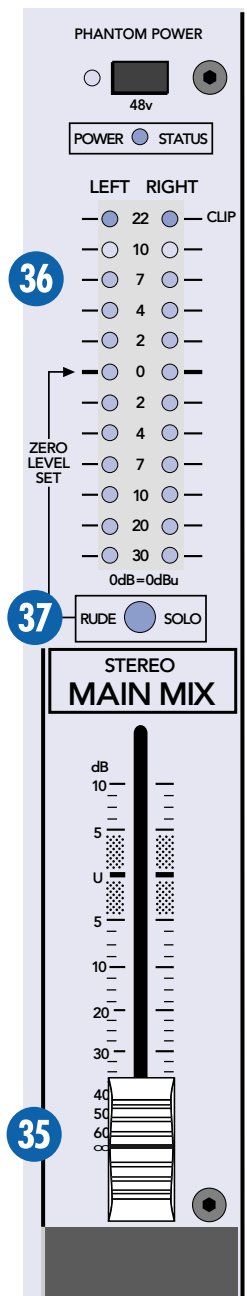

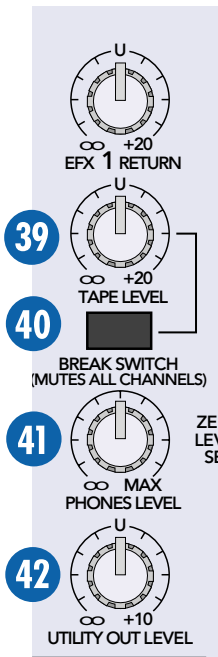
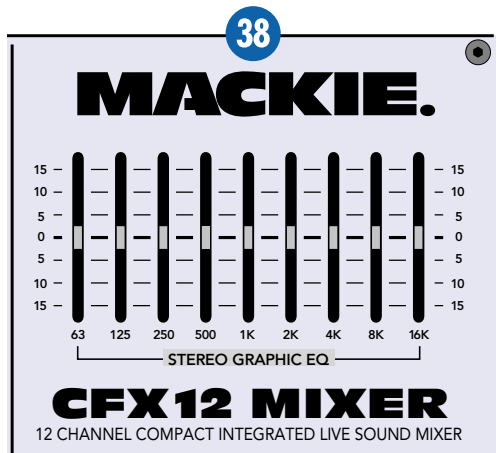

3. Slowly turn up the MAIN MIX Fader **35** until feedback just begins to occur. BE CAREFUL! Feedback can occur quickly and become very LOUD, very fast.
4. Cut the appropriate slider until feedback stops.

Suggestions for better sound:

- For better vocal sound, set the 125, 250, and 16K sliders to +5.
- **Note:** Make sure the singer is within 3 to 6 inches of the microphone. No amount of EQ can save a wandering minstrel.
- For more presence, set the 4K and 8K sliders to +5.
- To warm up the overall sound, set the 2K slider to -5.
- REMEMBER, LESS IS BETTER.

39 TAPE LEVEL

You can adjust the incoming level of your intermission entertainment, independent of the main mix level controls, via this feature. Here's how: Patch the stereo device into the TAPE INPUT **13**. Put the device in play. Engage the BREAK SWITCH **40** and set the TAPE LEVEL **39** knob as desired. Assuming the MAIN MIX Fader **35** is set, you should hear the device.

40 BREAK SWITCH

No, when we say BREAK SWITCH, we're not asking you to break the switch, we're offering you a very handy feature. When it's time for the talent to take a break, the engineer usually wants to stretch his legs. But walking away from a live mixer in a crowded club can be somewhat unnerving — what if some goon starts dinking around with the faders?

No problem. Just plug in your intermission entertainment device to the TAPE INPUT **13**

jacks and engage the BREAK SWITCH. Instantly, the entire main mix is switched off and the intermission entertainment is switched on.

Even if you just want silence during the breaks, this switch can act as a "Master Mute" switch, simply by plugging nothing into TAPE INPUT **13**.

41 PHONES LEVEL

After the MAIN MIX Fader **35**, the mix is sent through this knob, allowing you to set headphone levels as desired without disturbing the main mix level.

When a channel's SOLO PFL **34** is engaged, the main mix will be replaced by the solo signal, allowing the engineer to audition channels without disturbing the main mix.

The stereo PHONES jack **15** can drive any standard headphones to very loud levels. Walkperson-type phones can also be used with an appropriate adapter.

Note: Please see the "Safety Instructions" on page 2 for information on hearing protection.

42 UTILITY OUT LEVEL

After the MAIN MIX Fader **35**, the mix is sent through this knob, allowing you to set the levels at the UTILITY OUT **8** as desired without disturbing the main mix level.

43 SUB FADERS

The typical exit for channel signals is through one or more sub mixes. The sub mix signal is first controlled by this fader, which provides 10 dB of gain fully up, unity gain at the "U" mark, and is effectively muted fully down.

From here, the signal goes to two very different locations: SUB OUT **9** sends the sub mix directly out of the mixer via its TRS jacks; and SUB ASSIGN **44** sends it to the MAIN MIX Fader **35**.

44 LEFT/RIGHT SUB ASSIGN

As discussed in ASSIGN **32**, the only way to get channel outputs to the main mix is via the sub mixes, and this switch is the key.

Continuing the assumption made in ASSIGN **32**, Subs 1 and 2 are the left-right stereo path from the channels to SUB Faders **43** 1 and 2, with SUB 1 carrying the left signal and SUB 2 carrying the right. Engage SUB 1 ASSIGN LEFT and SUB 2 ASSIGN RIGHT, and you're done. Take a look at the block diagram on page 22 — it'll explain this and more, but in hieroglyphics.

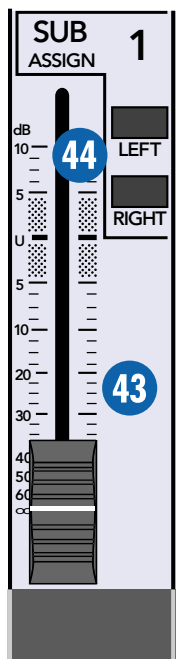

45 AUX MASTER SEND

Aux send signals are derived by each channel's AUX 25 knob, mixed together, then sent through this AUX MASTER SEND knob. Turned fully up, it provides 15 dB of additional gain, the center "U" mark is unity gain, and fully down is off.

Typically, when the talent (or lack thereof) wants a louder monitor mix, this is the knob to crank up — watch out for feedback!

46 EFX 1 MASTER SEND

Effects send signals are derived by each channel's EFX 1 (EXT) 27 knob, mixed together, then sent through this EFX 1 MASTER SEND knob. Turned fully up, it provides 15 dB of additional gain, the center "U" mark is unity gain, and fully down is off.

Being that this controls only post-fader sends destined for outboard effects devices, you'll typically set this knob near the "U" mark and then leave it alone.

47 EFX 1 RETURN

Stereo signals come through the EFX 1 RETURN and continue on to the MAIN MIX Fader 35. They contain the effects' "wet" signals to be mixed together with the channels' "dry" original signals. Turned fully up, it provides 15 dB of additional gain, the center "U" mark is unity gain, and fully down is off.

Being that this controls only the return signals of external effects, with their levels already determined by the channels' EFX 1 (EXT) 27 knob, you'll typically set this knob near the "U" mark and then leave it alone.

48 EMAC EFFECTS PROCESSOR

FOR THE IMPATIENT:

Set EFX 2 SEND 49 and TO MAIN MIX 50 at the center "U" mark. Assuming you have your basic mix up and running, turn up the EFX 2 (INT) 28, per channel. This feeds in individual amounts of channel signals to the EMAC inputs — you should be hearing the effects as you do this.

Next, goof around with the various parameters: Preset Select 52, TIME/RATE 53, DAMP-

ING/DEPTH 54 and WIDE 55. When you find an effect you like, jot down the parameters, then goof around some more.

To mute these effects, engage BYPASS 56 (or your foot switch if connected to EFX FOOT SWITCH 16). To send these effects to the stage monitor cues, turn up the EFFECTS TO MONITOR 51 knobs.

FOR THE CURIOUS:

EMAC™ stands for Extended Multiply and Accumulate, which is a proprietary 32-bit digital stereo processor developed by our Digital Engineering Group. It provides 16 preset digital effects algorithms for you to select. In addition to the presets, there are two parameter controls (53 54) you can adjust to change the sound and make it unique for your particular application.

49 EFX 2 SEND

This controls the signal level being sent to the input of the EMAC module (and to the EFX SEND 2 11 jack). Use the EFX 2 (INT) 28 controls on the individual channels to adjust the amount of each channel's signal you want to go to the EMAC. Leave EFX 2 SEND set at the center "U" position. If you find that you're not getting enough of the effect in the main mix, make sure that the TO MAIN MIX 50 control is turned up at least to unity (the center detent position). It's okay to turn up the EFX 2 SEND some more if you need to. Just make sure the ZERO LEVEL 57 LED never lights more than occasionally. Read on to find out why.

50 TO MAIN MIX

Stereo signals (from STEREO EFX RETURN 2 12 and EMAC EFFECTS PROCESSOR 48) come through this TO MAIN MIX knob and continue on to the MAIN MIX Fader 35. They contain the effects' "wet" signals and are mixed together with the channels' "dry" original signals. Turned fully up, it provides 15 dB of additional gain, the center "U" mark is unity gain, and fully down is off.

Being that this controls only the return signals of external and

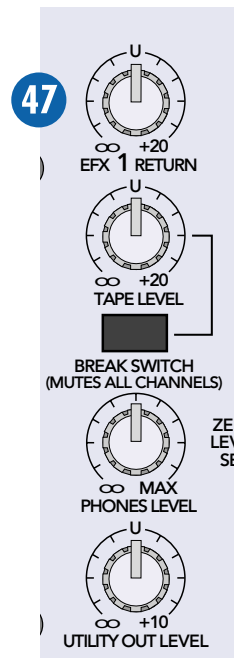
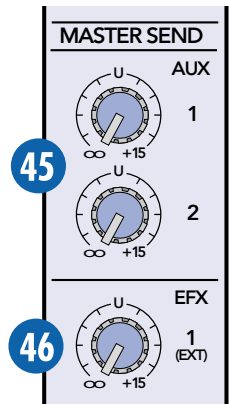
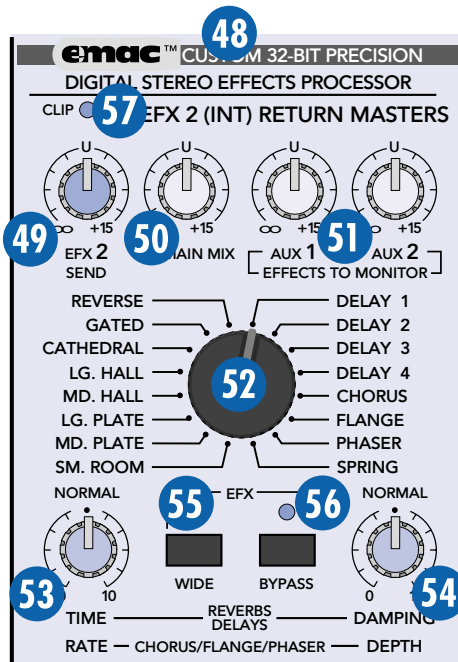

EMAC effects, with their levels already determined by the channels' EFX 2 (EXT) knob, you'll typically set this knob near the "U" mark and then leave it alone.

51 EFFECTS TO MONITOR

This works just like the channel AUX 25 knobs, but here, the source signal is the EFX 2 RETURN and the EMAC output. Typically, this knob is used to add effects to the stage monitors.

Turned fully up, it provides 15 dB of additional gain, the center "U" mark is unity gain, and fully down is off.

52 PRESET SELECT

Rotate this detented switch to select the preset effect you want to use.

Preset Effects Descriptions

Reverbs

The reverbs are designed to provide a wide variety of reverb sounds for vocal and instrument applications. In the following description, *tail* refers to the reflections that follow the initial sound event, also referred to as *decay range*. *Pre-delay* is the amount of time between the initial sound event and the first reflection.

TIME/RATE 53 controls the length of the tail, with the shortest tail at the 0 position and the longest tail at 10. DAMPING/DEPTH 54 controls the damping, with the darkest tone at 0 and the brightest tone at 10. The WIDE 55 switch is very effective at increasing the stereo image of the reverb effect.

REVERSE: Standard reverse reverb, simulating a tail-first effect increasing to the original note. Decay range is adjustable from 35ms to 515ms. No pre-delay.

GATED: Standard gated reverb, where the reverb tail is cut off sharply after the preset decay length. Decay range is adjustable from 35ms to 515ms. No pre-delay.

CATHEDRAL: Dense, smooth reverb with very long tail, long pre-delay, and late reflections. Tails are very warm with some additional high-end reflections imitating the stone walls of a cathedral.

A very dramatic effect that works well with wind instruments such as flute, slow finger picking on acoustic guitar, and quiet vocal group harmony and choirs. Also works well with keyboards and drums using short decay. Decay range is adjustable from 2 seconds to 10 seconds. Pre-delay set at 75ms.

LG. HALL: Dense, smooth reverb with long tail, long pre-delay, and some early reflections. Tails are warm with more apparent high end. Works well with vocals and electric and acoustic guitar. Decay range is adjustable from 1 second to 5 seconds. Pre-delay set at 75ms.

MD. HALL: Dense, smooth reverb with normal tail, normal pre-delay, and increased early reflections. Tails are warm with more apparent high end. Works well with vocals and electric and acoustic guitar. Decay range is adjustable from 750ms to 2.5 seconds. Pre-delay set at 65ms.

LG. PLATE: Good early reflections and no pre-delay. Tails are normal and warm with strong high end for increased presence. Perfect for vocals and snare. Decay range is adjustable from 1 second to 5 seconds. No pre-delay.

MD. PLATE: Good early reflections and no pre-delay. Tails are short and warm with strong high end for increased presence. Perfect for tight vocals and snare. Decay range is adjustable from 750ms to 2.5 seconds. No pre-delay.

SM. ROOM: Reverb featuring very fast and scattered early reflections with a short pre-delay. Tails are very short and warm with normal high-end imitating absorbent wall materials and audience. Good for tight vocal effects. Decay range is adjustable from 250ms to 1 second. Pre-delay set at 30ms.

SPRING: Mimics the vintage 60's-style wet spring reverb effect. Tails are normal with strong high end and a slight waver imitating the slow flutter of the mechanical spring system. Very good with acoustic guitar. Decay range is adjustable from 1 second to 5 seconds. No pre-delay.

Delays

There are four delays available with one, two, three, and four repeats. TIME/RATE 53 controls the time between repeats, with the fastest repeats at the 0 position and the

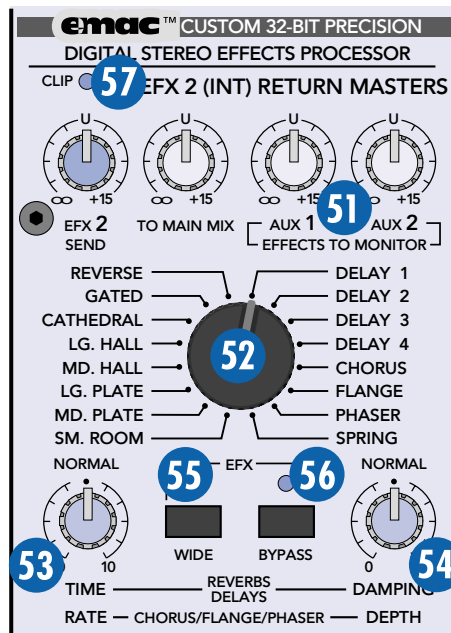

slowest repeats at 10. **DAMPING/DEPTH** 54 controls the damping, with the darkest tone at 0 and the brightest tone at 10. Since the delay effect is not stereo, it is not affected by the **WIDE** 55 switch.

DELAY 1: One repeat. Works best for slapback delay used in country and swing guitar, and for rockabilly and some country vocals. Delay range is adjustable from 5ms to 524ms.

DELAY 2: Two repeats. Provides a fuller, more dramatic effect for rock and gospel vocals, acoustic guitar, and wind instruments such as flute. Especially effective for some finger-picking styles. Delay range is adjustable from 5ms to 524ms.

DELAY 3: Three repeats. An excellent delay for slow, bluesy vocals and melodic flute music. This delay usually works best when the channel **EFX send** is set at less than halfway. Delay range is adjustable from 5ms to 524ms.

DELAY 4: Four repeats. This is for very dramatic delay effects, particularly for enhancing long vocal notes and dramatic instrumental note-chopping effects. Be sure to set the channel **EFX send** at about halfway. Delay range is adjustable from 5ms to 524ms.

Modulation Effects

These include Chorus, Flange, and Phaser, and are generally used for enhancement of instrumental music. However, Chorus adds a dramatic effect to vocals as well. The **WIDE** 55 switch is very effective at dramatically increasing the strength and thickness of a modulation effect. For example, using **WIDE** on Chorus mimics a multi-voiced chorus effect.

TIME/RATE 53 controls the effect Rate, which is the speed of the sweeping effect. Fully counter-clockwise produces the slowest sweeps and fully clockwise produces the fastest.

DAMPING/DEPTH 54 controls the effect depth, which is the strength of the sweeping effect. Fully counter-clockwise produces the lightest sweeping effect and fully clockwise produces the thickest.

CHORUS: Provides a soft, ethereal sweeping effect. Perfect for enhancement of electric and acoustic guitar and bass. Also adds a dramatic effect to vocals, particularly group harmonies and choirs. The channel's **EFX 2 (INT)** 28 should be set halfway or higher. Rate is adjustable from 0.5Hz to 30Hz. Depth is adjustable from 0% to 100%.

FLANGE: Creates a strong sweeping effect, particularly effective on rock electric guitar, lead and rhythm. The channel's **EFX 2 (INT)** 28 should be set halfway or higher. Rate is adjust-

able from 0.5Hz to 20Hz. Depth is adjustable from 0% to 100%.

PHASER: This effect is perfect for enhancing strummed acoustic guitar or electric guitar power chords. The **PHASER** effectively duplicates the popular 70's phase shift effect used for guitar. Rate is adjustable from 0.5Hz to 35Hz. Depth is adjustable from 50% to 100%.

53 TIME/RATE

If you have a reverb effect selected, this control adjusts how long the reverberation lasts, with 0 being a short reverb time and 10 being the longest.

If you have a delay effect selected, this adjusts the amount of time between the original signal and the delayed signal, with 0 being a short delay time and 10 being the longest delay time.

If you have a chorus, flange, or phaser effect selected, this control adjusts the rate or speed of the modulation of the effect.

54 DAMPING/DEPTH

If you have a reverb or delay effect selected, this control adjusts how fast the higher frequencies roll off in the reverberation or delay, with 0 having little roll off and 10 having the most roll off.

If you have a chorus, flange, or phaser effect selected, this control adjusts the depth of the modulation of the effect.

55 WIDE

Depending on the effect selected, this switch adds more width or depth to the effect. Note that it doesn't work with the **DELAY** and **PHASER** effects because they are monophonic.

56 BYPASS

Pushing in this button causes the adjacent **EFX BYPASS** indicator to light and mutes the effects' output signal. It affects only the internal **EMAC** effects, not any external effects processor you may have connected to the **STEREO EFX RETURN 2** 12 jack.

57 CLIP

This indicates when the **EMAC** is 6 dB below clipping. Just like the channels' **ZERO LEVEL** 23 LED, this LED should only light occasionally. If it blinks frequently, you should turn down **EFX 2 SEND** 49 a little.

GENERAL PRECAUTIONS AND CONSIDERATIONS



NEVER bypass the AC plug's ground pin. This is dangerous!

AC Power Distribution

The majority of AC outlets encountered in homes and clubs (in the U.S.) are served by a 240VAC center-tapped service entrance transformer. This provides two phases of AC power on either side of the center tap, at 120V each.

If lighting is used in a show, it is preferable to power the lights from one leg of the service, and power the audio equipment from the other leg. This will help minimize noise from the lights coupling into the audio (particularly if SCRs, or light-dimmer switches, are used).

In order to minimize ground loops, the safety grounds for all the outlets should be connected to a common (“star”) grounding point, and the distance between the outlets and the common grounding point should be as short as possible.

When setting up for a show, oftentimes you are plugging into an AC power distribution system you know nothing about. You may even be faced with 2-wire outlets that are missing the third safety ground pin. It's a good idea to have a three-wire AC outlet tester in your toolbox so you can check the outlets yourself to make sure they are wired correctly. These testers will tell you if the polarity of the hot and neutral wires is reversed and if the safety ground is disconnected. Don't use an outlet if it is wired improperly! This is to protect yourself as well as your equipment.

If you find that you must plug into a two-wire outlet, you will need to use a two-wire to three-wire adapter (cheater plug). These come with a metal tab that you put underneath the center screw that holds the AC outlet faceplate in place. This center screw *must* be grounded. You can check it by connecting the adapter to the outlet and then plugging in your handy-dandy AC outlet tester.

APPENDIX A: Service Info

Warranty Service

Details concerning Warranty Service are spelled out page 23.

If you think your CFX Mixer has a problem, please do everything you can to confirm it before calling for service. Doing so might save you from the deprivation of your mixer and the associated suffering.

Of all Mackie products returned for service (which is hardly any at all), roughly 50% are coded “CND” — Could Not Duplicate, which usually means the problem lay somewhere other than the mixer. These may sound obvious to you, but there's some things you can check. Read on.

Troubleshooting

Bad Channel

- Is the ASSIGN **32** switch set correctly?
- Is the channel Fader **33** turned up?
- On mono channels, try unplugging any INSERT devices.
- Try the same source signal in another channel, set up exactly like the suspect channel.

Bad Output

- Are the SUB ASSIGN **44** switches set correctly?
- Are the MAIN MIX Fader **35** and SUB Faders **43** turned up?
- If it's one of the MAIN OUTs **5**, try unplugging all the others. For example, if it's a TRS MAIN OUT, unplug the associated XLR outputs. If the problem goes away, it's not the mixer.
- If it's a stereo pair, try switching them around. For example, if a left output is presumed dead, switch the left and right cords, at the mixer end. If the left speaker is still dead, it's not the mixer.

Noise

- Turn the channel Faders **33**, EFX 1 RETURN **47** and EFX 2 SEND **49** down, one by one. If the sound disappears, it's either that channel or whatever is plugged into it, so unplug whatever that is. If the noise disappears, it's from your whatever.

Power

- Our favorite question: Is the POWER switch on?

Repair

Service for the CFX Series mixers is available only at our factory, located in sunny Woodinville, Washington. Service for Mackie mixers living outside the United States can be obtained through local dealers or distributors.

If your mixer needs service, follow these instructions:

1. Review the preceding troubleshooting suggestions. Please.
2. Call Tech Support at 1-800-258-6883, 8am to 5pm PST, to explain the problem and request an RA (Return Authorization) number. Have your mixer's serial number ready. *You must have an RA number before you can obtain service at the factory.*
3. Keep this owner's manual. We don't need it to repair the mixer.
4. Pack the mixer in its original package, including endcaps and box. This is *very important*. When you call for the RA number, please let Tech Support know if you need new packaging. *Mackie is not responsible for any damage that occurs due to non-factory packaging.*
5. Include a legible note stating your name, shipping address (no P.O. boxes), daytime phone number, RA number, and a detailed description of the problem, including how we can duplicate it.
6. Write the RA number in **BIG PRINT** on top of the box.
7. Ship the mixer to us. We suggest insurance for all forms of cartage. Ship to this address:

Mackie Designs
SERVICE DEPARTMENT
16140 Wood-Red Rd. NE, Ste. 5
Woodinville, WA 98072

8. We'll try to fix the mixer within five business days. Ask Tech Support for current turn-around times when you call for your RA number. We normally send everything back prepaid using UPS ORANGE (three-day air). However, if you rush your mixer to us by Next Day Air, we'll treat it in kind by shipping it back to you the same way in which it was received. This paragraph does not necessarily apply to non-warranty service.

APPENDIX B: Technical Info

Specifications CFX•12, CFX•16, CFX•20

Mixer Section

Frequency Response

Mic Input to any Output (Trim at 0 dB):
+0, -1 dB, 32Hz to 20kHz

Distortion

THD and SMPTE IMD; 20Hz to 20kHz

Mic Input to Main Output:
< 0.05% @ +4 dBu output

Noise

20Hz to 20kHz BW (150Ω source impedance)

Equivalent Input Noise (EIN):
-127 dBu

Residual Output Noise:
Main, Monitor, & Effects outputs
Channel & Master levels off
-95 dBu

Common Mode Rejection Ratio (CMRR)

60 dB @ 1kHz, Trim @ 0 dB

Crosstalk

Adjacent Inputs or Input to Output:
-90 dB @ 1kHz

Fader Off
-90 dB @ 1kHz

Mute Switch and Break Switch Mute
-80 dB @ 1kHz

Input Level Trim Control Range

+6 to -50 dB

Phantom Power

+48V DC

Equalization

Low Cut: 100Hz, -18 dB/octave

Mono Channel EQ:

High ±15 dB @ 12kHz

Mid ±15 dB @ 100Hz to 8kHz

Low ±15 dB @ 80Hz

Stereo Channel EQ:

High ±15 dB @ 12kHz

High Mid ±15 dB @ 3kHz

Low Mid ±15 dB @ 400Hz

Low ±15 dB @ 80Hz

Graphic EQ (9 bands):

Q = 1.414, ISO octave centers

±15 dB @ 63, 125, 250, 500, 1k, 2k, 4k, 8k, 16k Hz

Mixer Rated Output

Main, Sub, Aux, & Efx: +4 dBu

Maximum Rated Output: +20 dBu

Maximum Input Levels

Mic Input: -28 dBu, Trim @ +50 dB
+18 dBu, Trim @ +6 dB

Line Input: -8 dBu, Trim @ +30 dB
+38 dBu, Trim @ -15 dB

Insert Input, Stereo Line Input, Tape Input, and
Effects Return: +20 dBu

Maximum Voltage Gain

Mic Input to

Insert Output:	50 dB
Tape Output:	66 dB
Sub Output:	66 dB
Main Output:	76 dB
Aux Send:	71 dB

Line Input to

Insert Output:	30 dB
Tape Output:	46 dB
Sub Output:	46 dB
Main Output:	56 dB
Aux Send:	51 dB

Stereo Line Input to

Tape Output:	40 dB
Sub Output:	40 dB
Main Output:	50 dB
Aux Send:	45 dB

Tape Input to

Main Output:	30 dB
--------------	-------

Effects Return to

Main Output:	30 dB
--------------	-------

CFX*12
WEIGHT
17.8 lbs.
(8.1 kg)

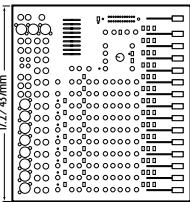

CFX*16
WEIGHT
21.0 lbs.
(9.5 kg)

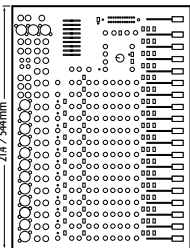

CFX*20
WEIGHT
24.3 lbs.
(11.0 kg)

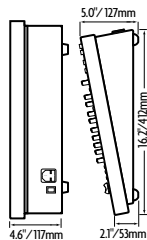
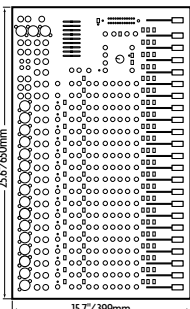

Input Impedance

Mic Input:	3kΩ, balanced
Line Input:	40kΩ, balanced
Insert Input, Stereo Line Input, Tape Input, and Effects Returns:	10kΩ, unbalanced

Output Impedance

Main Output, Insert Output, Tape Output, Sub Output, and Effects Sends: 150Ω

Digital Effects

Resolution:	16-bit, 2-channel
Number of Presets:	16

Channel Level Set LED (Sensitivity)

0 dBu (normal operating level)

VU Meters

Main L/R
12 segments:
Clip, +10, +7, +4, +2, 0, -2, -4, -7, -10, -20, -30

Disclaimer

Since we are always striving to make our products better by incorporating new and improved materials, components, and manufacturing methods, we reserve the right to change these specifications at any time without notice.

Block Diagram CFX Series

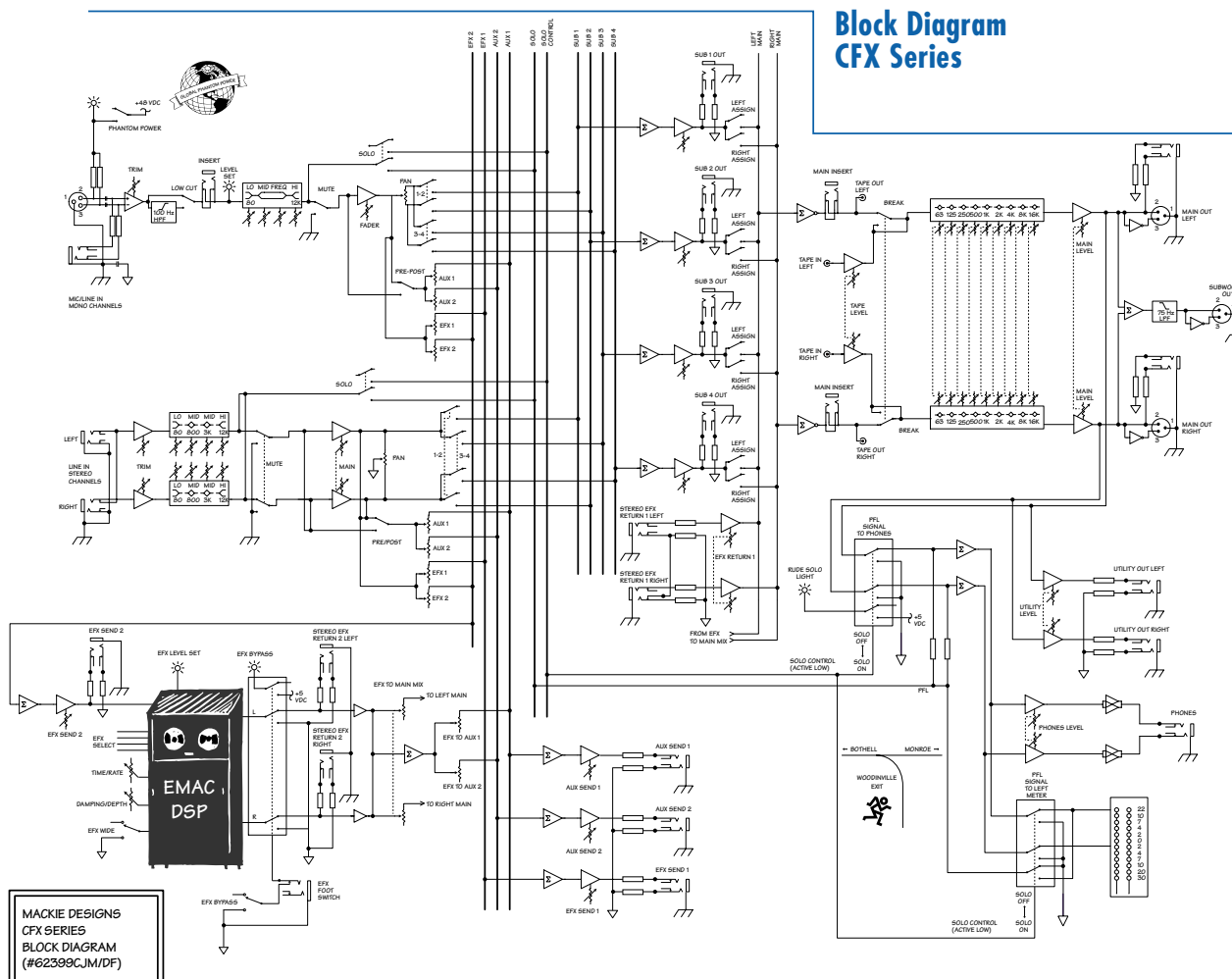

MACKIE DESIGNS
CFX SERIES
BLOCK DIAGRAM
(#62399CJM/DF)



CFX SERIES LIMITED WARRANTY

Please keep your sales receipt in a safe place.

A. Mackie warrants all materials, workmanship and proper operation of this CFX Series product for a period of **one year** from the original date of purchase. If you complete the optional questionnaire portion of the Product Registration Card, the warranty will be extended for an **additional two years**, but during the additional two years the labor for replacing slide potentiometers will be excluded from warranty coverage and may be billed to you. If any defects are found in the materials or workmanship or if the product fails to function properly during the applicable warranty period, Mackie, at its option, will repair or replace the product. **This warranty applies only to equipment sold and delivered within the U.S. by Mackie or its authorized dealers.**

B. Failure to return the card will not void the 1-year warranty.

C. Service and repairs of Mackie products are to be performed **only** at the factory. Unauthorized service, repairs, or modification will void this warranty.

D. To obtain factory service:

1. Call Mackie at **800/258-6883**, 8AM to 5PM Monday through Friday (Pacific Time) to get a Return Authorization (RA). Products returned without an RA number will be refused.
2. Pack the CFX Series product in its original shipping carton. If you do not have the carton, just ask for one when you get your RA number, and we'll send a shipping carton out promptly. More information on packing can be found in the *Service* section of the appropriate manual. Also include a note explaining exactly how to duplicate the problem, a copy of the sales receipt with price and date showing, and your return street address (no P.O. boxes or route numbers, please!). If we cannot duplicate the problem at the Mackie Factory or establish the starting date of your Limited Warranty, we may, at our option, charge for service time.
3. Ship the product in its original shipping carton, **freight prepaid** to:

**Mackie Designs Inc.
SERVICE DEPARTMENT
16140 Wood-Red Road NE, Ste. 5
Woodinville, WA, 98072, USA**

IMPORTANT: Make sure that the RA number is plainly written on the shipping carton.

E. Mackie reserves the right to inspect any products that may be the subject of any warranty claims before repair or replacement is carried out. Mackie may, at their option, require proof of the original date of purchase in the form of a dated copy of the original dealer's invoice or sales receipt. Final determination of warranty coverage lies solely with Mackie Designs Inc.

F. Mackie CFX Series products returned to Mackie and deemed eligible for repair or replacement under the terms of this warranty will be repaired or replaced within thirty days of receipt by Mackie at our rainforest factory complex. Products returned to Mackie that do not meet the terms of this Warranty will be repaired and returned C.O.D. with billing for labor, materials, return freight, and insurance. Products repaired under warranty at Mackie's factory will be returned freight prepaid by Mackie to any location within the boundaries of the USA.

G. This warranty is extended to the original purchaser and to anyone who may subsequently purchase this product within the applicable warranty period.

H. This is your sole warranty. Mackie does not authorize any third party, including any dealer or sales representative, to assume any liability on behalf of Mackie Designs or to make any warranty for Mackie Designs.

I. THE WARRANTY GIVEN ON THIS PAGE IS THE SOLE WARRANTY GIVEN BY MACKIE AND IS IN LIEU OF ALL OTHER WARRANTIES, EXPRESS AND IMPLIED, INCLUDING THE WARRANTIES OF MERCHANTABILITY AND FITNESS FOR A PARTICULAR PURPOSE. THE WARRANTY GIVEN ON THIS PAGE SHALL BE STRICTLY LIMITED IN DURATION TO ONE YEAR FROM THE DATE OF ORIGINAL PURCHASE FROM AN AUTHORIZED MACKIE DEALER. UPON EXPIRATION OF THE APPLICABLE WARRANTY PERIOD, MACKIE SHALL HAVE NO FURTHER WARRANTY OBLIGATION OF ANY KIND. MACKIE SHALL NOT BE LIABLE FOR ANY INCIDENTAL, SPECIAL, OR CONSEQUENTIAL DAMAGES THAT MAY RESULT FROM ANY DEFECT IN THE MACKIE PRODUCT OR ANY WARRANTY CLAIM. Some states do not allow exclusion or limitation of incidental, special, or consequential damages or a limitation on how long warranties last, so some of the above limitations and exclusions may not apply to you. This warranty provides specific legal rights and you may have other rights which vary from state to state.

Contributors and Colophon

Manual composed by Jeff Gilbert, the original 10-year Mackoid (not counting Greg, of course). It was created in just 3 hours, using a mascara pencil applied to cocktail napkins in the back booth of a diner in Bothell WA. He then borrowed snippets of text found lying on the floor of Mackie's Engineering and Advertising departments and pasted them in, using cat saliva. It was really quite disgusting, so he turned it all over to Dave Franzwa, a REAL technical writer, to gussy it up.

Additional input provided by Paul Larson, Tech Support guru, Rick Bos, CFX Series Product Manager (and tall, cool guy), and CJ Murray, project engineer. Proofreading provided by honorary Mackoid Linn Compton.

Typesetting was performed on a Power Macintosh® 8100/100AV using Adobe® PageMaker® 6.5. Illustrations were created using Adobe® Illustrator® 7.0. Fonts used include ITC Century Light Condensed, Avenir Roman, and Tekton. Sub-headings were made with Futura Condensed. Font management provided by Adobe® Type Manager® Deluxe 4.0 and Type Reunion® Deluxe 2.0.

"Mackie," the "Running Man" figure, "CFX," and "EMAC" are trademarks or registered trademarks of Mackie Designs Inc.

All other brand names mentioned are trademarks or registered trademarks of their respective holders, and are hereby acknowledged.



*Some of the
people at our
factory who helped
design, build, sell,
and support your
product.*

MACKIE®

Mackie Designs Inc.

16220 Wood-Red Rd. NE • Woodinville, WA 98072 • USA
US & Canada: 800/898-3211

Europe, Asia, Central & South America: 425/487-4333

Middle East & Africa: 31-20-654-4000

Fax: 425/487-4337 • www.mackie.com

E-mail: sales@mackie.com